

markilux 75

The patented side blind. Prevents inquisitive glances, protects against low-lying sun and light wind. The markilux that opens up into much more than it seems

markilux

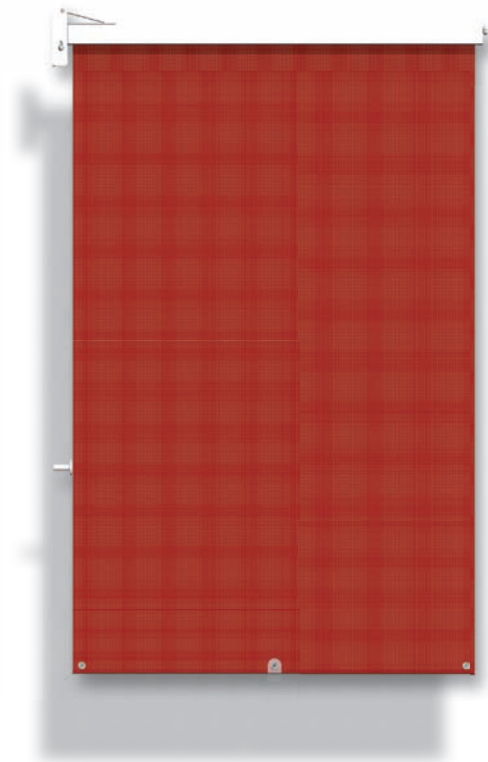

markilux 75

The patented side blind. Prevents inquisitive glances, protects against low-lying sun and light wind. The markilux that opens up into much more than it seems

Design features

- when retracted the cover is protected from the weather by the cassette, which encloses it completely
- slim cassette, only 60 mm x 60 mm in size
- for long-lasting attractiveness the awning has been powder coated
- one-piece covers made from widely woven, plain awning fabrics make it possible to do away with seams entirely

Technical highlights

- the cover can be extended continuously up to a maximum drop of 200 cm so allowing the ideal degree of privacy and sun protection
- when not in use, the cassette is simply folded down and fixed inconspicuously against the wall
- with locking mechanism to prevent the screen rolling up unintentionally in a gust of wind

markilux 75

markilux Collection

Specification

markilux ES-1

markilux 6000

markilux 5010

markilux 3300 / 3300 pur

markilux 990

markilux 1200

markilux 1200 stretch

markilux 1500

markilux 1550

markilux 1600

markilux 1600 stretch

markilux 1600 pavilion 2

markilux 1650

markilux 930 swing

markilux 1000

markilux 1000 stretch

markilux 1100

markilux 1300

markilux 1300 stretch

markilux 790

markilux 75

Optional Accessories

Technical Information

Fitting Accessories

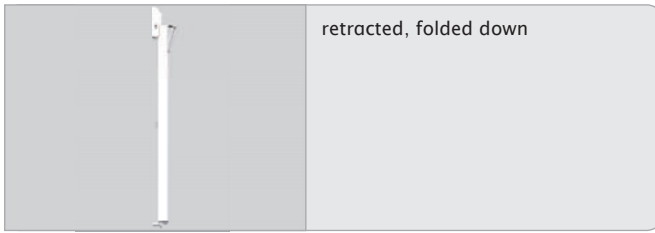

retracted, folded down

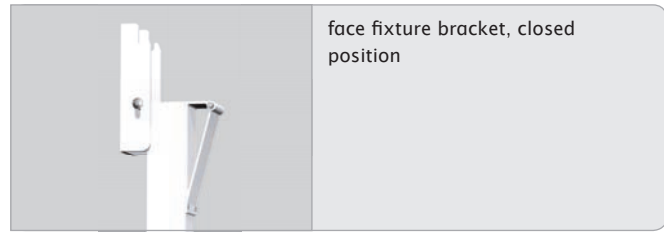

face fixture bracket, closed position

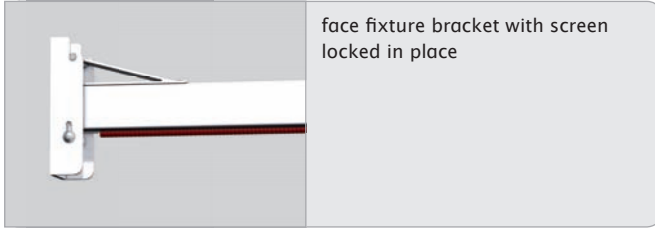

face fixture bracket with screen locked in place

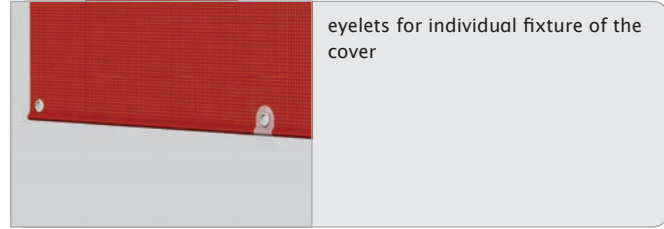

eyelets for individual fixture of the cover



locking mechanism to secure it against wind

Standard specification

face fixture

eyelets to attach the bottom of the cover to the ground

sunsilk snc fabric

sunsilk snc signature fabric

acrylic fabric 34

widely woven acrylic fabric

perfortex fabric

transolair fabric

Standard frame colours

traffic white - RAL 9016

Optional accessories

special powder-coated finish

Dimensions and configuration options

unit height	screen width	
	200	128

dimensions in cm

 = available, cover width 120 cm

 = available, cover width 162 cm

Covers

sunsilk snc (fabric series 324xx/329xx)	● ¹
sunsilk snc signature (fabric series 369xx)	● ¹
acrylic 34 (fabric series 341xx-347xx)	● ¹
widely woven acrylic fabric (pattern no. 34918 flecked eggshell)	● ²
widely woven acrylic fabric (fabric series 349xx)	● ³
sunsilk perla FR (fabric series 374xx/379xx)	–
perfortex (fabric series 333xx)	● ¹
transolair fabric (pattern no. 33911, light yellow)	● ²
transolair (fabric series 339xx)	● ³
Soltis 92	–
PVC fabric	–

● = standard specification

○ = optional accessories

– = not available

¹ = at a cassette width of 128 cm: all fabrics from the markilux collection at a cassette width of 170 cm only widely woven fabrics in acrylic (fabric series 349xx) and transolair (fabric series 339xx) possible

² = available from stock

³ = available to special order

Screen width definition: the screen width is measured with the screen unfolded from the end of the cassette to the wall.

Definition of the unit height: the unit height is measured with the screen unfolded from the top of the cassette to the bottom of the lath.

The width of the screen cover is always **less** than the width of the screen. For cover sizes please see the section "Housing Tolerances and Awning Cover Dimensions".

Programme: Standard specification (held in stock) - 6 pieces per delivery, bespoke specification (made to order) - individual delivery. Please consult the price list.

The stripes in patterned fabrics always run down the cover

Frame colours

traffic white - RAL 9016

special powder-coated finish



* Colours similar to the RAL chart - these may differ slightly from those depicted in both hue and finish.

Installation dimensions

Dimension overview

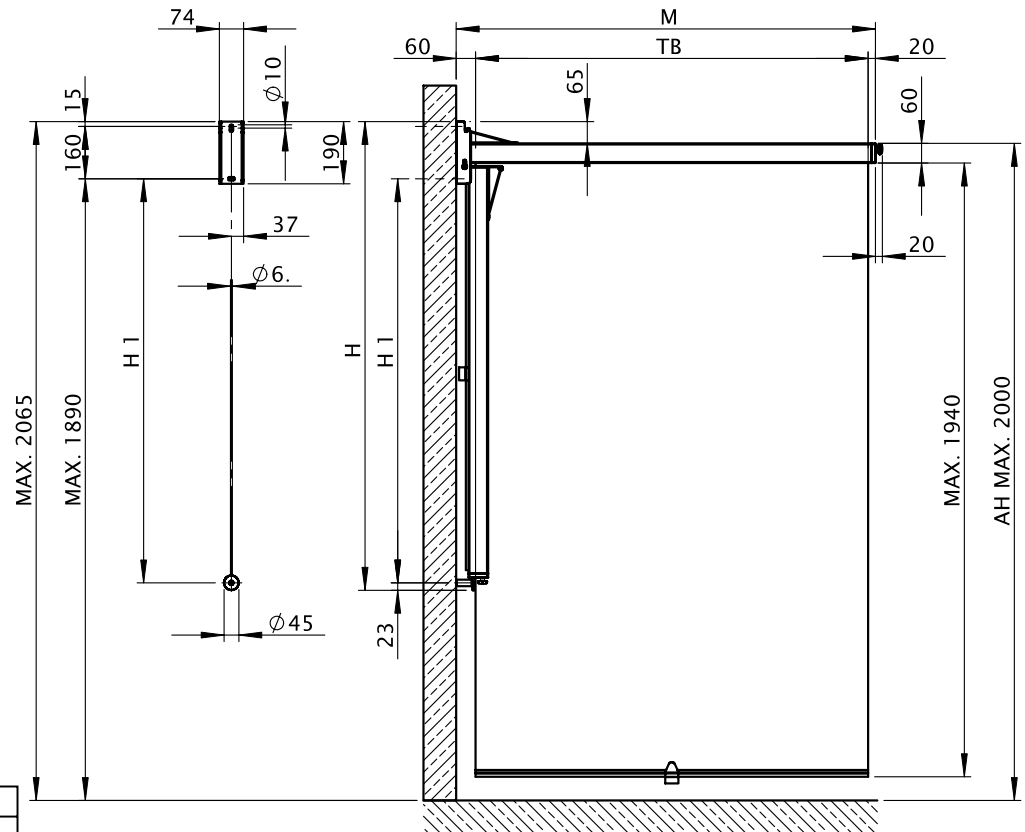

AM		
M	1280	1700
TB	1200	1620
H	1430	1850
H1	1230	1650

dimensions in mm

- M = overall screen width
- TB = cover width
- AH = unit height
- AM = installation dimensions
- H = cassette height including fixture bracket (retracted, folded down)
- H1 = installation dimensions of the fixture bracket